

## ORDER GUIDE

# **Seldén** Power Supply and SEL-Bus system



## Content

## Page

|                                 |    |
|---------------------------------|----|
| Introduction                    | 3  |
| 1. PSU-Start pack               | 3  |
| 2. Drive unit control pack(s)   | 4  |
| Furlex Electric                 | 5  |
| Synchronized Furling            | 6  |
| E40i                            | 7  |
| E-Series winch 40               | 8  |
| E-Series winch 46 & 52          | 9  |
| E-Series winch 60 & 66          | 10 |
| 3. Optional items               | 11 |
| Optional SEL-Bus & power cables | 12 |
| 4. Examples of installations    | 13 |

POWERED BY  
**SELBus**<sup>®</sup>

**ELECTRIC WINCHES  
MAST MOTOR**

**CXe**

**SMF**

SYNCHRONIZED MAIN FURLING

**FURLEX**  
*electric*

# Seldén Power Supply and SEL-Bus system

## Introduction

Choose one PSU Start pack per boat and one Control pack per drive unit. The packages are designed to include the minimum items necessary for a complete, standard installation. For systems with many drive units or long cable distances, additional cable lengths and sizes might be needed. See section 3 for additional items list. All items listed in the packages are also available to purchase separately.

Seldén Power Supply and SEL-Bus system can be extended at any time by adding extra drive unit(s) and respective control pack.

## 1. PSU start pack

One PSU start pack is normally needed per boat.  
Choose the package by battery voltage (for fuse/switch).

| Art. No.   | Description                              |                                                       | PSU Start pack 12V<br>532-800-20 | PSU Start pack 24V<br>532-800-30 | PSU Start pack (Excl. fuse)*<br>532-800-40 |
|------------|------------------------------------------|-------------------------------------------------------|----------------------------------|----------------------------------|--------------------------------------------|
| 532-800-10 | Power supply unit (PSU)                  |                                                       | 1                                | 1                                | 1                                          |
| 532-488    | Main switch/fuse 100A, (12v)             |                                                       | 1                                | -                                | -                                          |
| 532-492    | Main switch/fuse 60A, (24v)              |                                                       | -                                | 1                                | -                                          |
| 532-835    | SEL-Bus terminal, Female.                | <i>Ends of backbone</i><br>                           | 1                                | 1                                | 1                                          |
| 532-836    | SEL-Bus terminal, Male                   |                                                       | 1                                | 1                                | 1                                          |
| 532-839    | SEL-Bus T-connector (Female/Female/Male) | <i>Connects drop cables to backbone</i><br>           | 1                                | 1                                | 1                                          |
| 531-101    | SEL-Bus cable (Female/Male) 0,3M         | <i>Drop cable/Backbone</i><br>                        | 1                                | 1                                | 1                                          |
| 531-104    | SEL-Bus cable (Female/Male) 5M           |                                                       | 2                                | 2                                | 2                                          |
| 531-048-10 | Power Cable Pack, 2x9m**                 | <i>6mm² (yellow/dark blue) Connects PSU to MCU(s)</i> | 1                                | 1                                | 1                                          |
| 597-275-E  | I:MANUAL, EL.SYSTEM INSTALL.             |                                                       | 1                                | 1                                | 1                                          |

\*If fuse or integrated fuse/switch other than Seldén is used. Recommended size 12V= 120-160A (fast), or 24V=100-120A (slow), 24V=60-75A (fast) or 50-60A (slow).

\*\*Max total length of power cable (plus and minus) from PSU to MCU is 18m (2 x 9m). If longer cables are needed, increase cable area to 10 mm² . See section 3.

## 2. Drive Unit Control pack(s)

Select one control pack for each drive unit. A "drive unit" is an electrically powered function such as a Furlex Electric, CXe, Electric winches, etc. Choose the package by function, size and push button option.





| Art. No.   | Description                                                  |                                                                                       | CONTROL PACK<br>CXe25 & CXe45 |                             |
|------------|--------------------------------------------------------------|---------------------------------------------------------------------------------------|-------------------------------|-----------------------------|
|            |                                                              |                                                                                       | 532-815-70                    | Excl. buttons<br>532-815-71 |
| 532-815-24 | MCU (Motor Control Unit) CXe25/CXe45                         |    | 1                             | 1                           |
| 540-459-89 | Push buttons CXe, IN/OUT                                     |    | 1                             | -                           |
| 532-827-01 | SEL-Bus Push button converter for CXe25/CXe45 (excl buttons) |   | 1                             | 1                           |
| 532-839    | SEL-Bus T-connector (Female/Female/Male)                     |  | 2                             | 2                           |
| 531-102    | SEL-Bus cable (Female/Male), 1 M                             |  | 1                             | 1                           |
| 531-103    | SEL-Bus cable (Female/Male), 2 M                             |                                                                                       | 1                             | 1                           |

## Furlex Electric

| CONTROL PACK FURLEX ELECTRIC |                                                         |                                                                                     | 200/204E   |            |               | 300/304E   |            |               | 400/404E   |            |               |
|------------------------------|---------------------------------------------------------|-------------------------------------------------------------------------------------|------------|------------|---------------|------------|------------|---------------|------------|------------|---------------|
|                              |                                                         |                                                                                     | Genoa      | Cutter     | Excl. buttons | Genoa      | Cutter     | Excl. buttons | Genoa      | Cutter     | Excl. buttons |
| Art. No.                     | Description                                             |                                                                                     | 532-815-60 | 532-815-61 | 532-815-62    | 532-815-63 | 532-815-64 | 532-815-65    | 532-815-66 | 532-815-67 | 532-815-68    |
| 532-815-20                   | MCU (Motor Control Unit) Furlex 200/204E                |    | 1          | 1          | 1             | -          | -          | -             | -          | -          | -             |
| 532-815-21                   | MCU (Motor Control Unit) Furlex 300/304E                |                                                                                     | -          | -          | -             | 1          | 1          | 1             | -          | -          | -             |
| 532-815-22                   | MCU (Motor Control Unit) Furlex 400/404E                |                                                                                     | -          | -          | -             | -          | -          | -             | 1          | 1          | 1             |
| 540-459-06                   | Push button assembly GENOA IN/OUT                       |    | 1          | -          | -             | 1          | -          | -             | 1          | -          | -             |
| 540-459-09                   | Push button assembly CUTTER IN/OUT                      |                                                                                     | -          | 1          | -             | -          | 1          | -             | -          | 1          | -             |
| 532-827-01                   | SEL-Bus Push button converter for Furlex (excl buttons) |   | 1          | 1          | 1             | 1          | 1          | 1             | 1          | 1          | 1             |
| 532-839                      | SEL-Bus T-connector (Female/Female/Male)                |  | 2          | 2          | 2             | 2          | 2          | 2             | 2          | 2          | 2             |
| 531-102                      | SEL-Bus cable (Female/Male), 1 M                        |  | 1          | 1          | 1             | 1          | 1          | 1             | -          | -          | -             |
| 531-103                      | SEL-Bus cable (Female/Male), 2 M                        |                                                                                     | 1          | 1          | 1             | 1          | 1          | 1             | 2          | 2          | 2             |

## Synchronized Main Furling







To be able to use SMF (Synchronized Main Furling), the motor controller for the electric mast motor must be paired up with a suitable motor controller for the winch. The tables on page 7-10 show what SMF synchronized motor controller to select for the winch, based on the size of the mast motor RB, RC, RD and the winch.

| Description                                                                  | Art. No.   |                                                                                     | Mast Motor |                            |            |                            |            |                            |
|------------------------------------------------------------------------------|------------|-------------------------------------------------------------------------------------|------------|----------------------------|------------|----------------------------|------------|----------------------------|
|                                                                              |            |                                                                                     | RB         |                            | RC         |                            | RD         |                            |
|                                                                              |            |                                                                                     | 532-815-72 | Exc. buttons<br>532-815-73 | 532-815-75 | Exc. buttons<br>532-825-76 | 532-815-78 | Exc. buttons<br>532-815-79 |
| MCU (Motor Control Unit),<br>Mast Motor RB                                   | 532-815-33 |    | 1          | 1                          | -          | -                          | -          | -                          |
| MCU (Motor Control Unit),<br>Mast Motor RC                                   | 532-815-34 |                                                                                     | -          | -                          | 1          | 1                          | -          | -                          |
| MCU (Motor Control Unit),<br>Mast Motor RD                                   | 532-815-35 |                                                                                     | -          | -                          | -          | -                          | 1          | 1                          |
| Push button assembly<br>MAIN IN/OUT                                          | 540-459-07 |    | 1          | -                          | 1          | -                          | 1          | -                          |
| SEL-Bus Push button<br>converter for electric furling<br>mast (excl buttons) | 532-827-02 |   | 1          | 1                          | 1          | 1                          | 1          | 1                          |
| SEL-Bus T-connector<br>(Female/Female/Male)                                  | 532-839    |  | 2          | 2                          | 2          | 2                          | 2          | 2                          |
| SEL-Bus cable<br>(Female/Male), 1 M                                          | 531-102    |  | 1          | 1                          | 1          | 1                          | 1          | 1                          |
| SEL-Bus cable<br>(Female/Male), 2 M                                          | 531-103    |                                                                                     | 1          | 1                          | 1          | 1                          | 1          | 1                          |

# E40i

| Description                                               | Art. No.   |                                                                                     | E40i       |                             |             |                             |             |                             |
|-----------------------------------------------------------|------------|-------------------------------------------------------------------------------------|------------|-----------------------------|-------------|-----------------------------|-------------|-----------------------------|
|                                                           |            |                                                                                     | BASIC      |                             | SMF SYNC RB |                             | SMF SYNC RC |                             |
|                                                           |            |                                                                                     | 532-815-80 | Excl. buttons<br>532-815-81 | 532-815-82  | Excl. buttons<br>532-825-83 | 532-815-85  | Excl. buttons<br>532-815-86 |
| MCU (Motor Control Unit), BASIC                           | 532-815-40 |    | 1          | 1                           | -           | -                           | -           | -                           |
| MCU (Motor Control Unit),<br>SMF SYNC RB                  | 532-815-41 |                                                                                     | -          | -                           | 1           | 1                           | -           | -                           |
| MCU (Motor Control Unit),<br>SMF SYNC RC                  | 532-815-42 |                                                                                     | -          | -                           | -           | -                           | 1           | 1                           |
| Push button assembly for winch,<br>1-2                    | 540-457-01 |    | 1          | -                           | 1           | -                           | 1           | -                           |
| SEL-Bus Push button converter<br>for Winch (excl buttons) | 532-827-01 |    | 1          | 1                           | 1           | 1                           | 1           | 1                           |
| Button protection panel<br>Excl. buttons                  | 540-482    |  | 1          | -                           | 1           | -                           | 1           | -                           |
| SEL-Bus T-connector<br>(Female/Female/Male)               | 532-839    |  | 2          | 2                           | 2           | 2                           | 2           | 2                           |
| SEL-Bus cable (Female/Male), 1 M                          | 531-102    |  | 1          | 1                           | 1           | 1                           | 1           | 1                           |
| SEL-Bus cable (Female/Male), 2 M                          | 531-103    |                                                                                     | 1          | 1                           | 1           | 1                           | 1           | 1                           |







## E-Series winch 40

|                                                         |            |                                                                                     | E40        |                             |             |                             |             |                             |
|---------------------------------------------------------|------------|-------------------------------------------------------------------------------------|------------|-----------------------------|-------------|-----------------------------|-------------|-----------------------------|
|                                                         |            |                                                                                     | BASIC      |                             | SMF SYNC RB |                             | SMF SYNC RC |                             |
| Description                                             | Art. No.   |                                                                                     | 532-825-01 | Excl. buttons<br>532-825-02 | 532-825-03  | Excl. buttons<br>532-825-04 | 532-825-05  | Excl. buttons<br>532-825-06 |
| MCU (Motor Control Unit), BASIC                         | 532-815-44 |    | 1          | 1                           | -           | -                           | -           | -                           |
| MCU (Motor Control Unit), SMF SYNC RB                   | 532-815-45 |                                                                                     | -          | -                           | 1           | 1                           | -           | -                           |
| MCU (Motor Control Unit), SMF SYNC RC                   | 532-815-46 |                                                                                     | -          | -                           | -           | -                           | 1           | 1                           |
| Push button assembly for winch, 1-2                     | 540-457-01 |    | 1          | -                           | 1           | -                           | 1           | -                           |
| SEL-Bus Push button converter for Winch (exc.l buttons) | 532-827-01 |    | 1          | 1                           | 1           | 1                           | 1           | 1                           |
| Button protection panel<br>Excl. buttons                | 540-482    |   | 1          | -                           | 1           | -                           | 1           | -                           |
| SEL-Bus T-connector (Female/<br>Female/Male)            | 532-839    |  | 2          | 2                           | 2           | 2                           | 2           | 2                           |
| SEL-Bus cable (Female/Male), 1 M                        | 531-102    |  | 1          | 1                           | 1           | 1                           | 1           | 1                           |
| SEL-Bus cable (Female/Male), 2 M                        | 531-103    |                                                                                     | 1          | 1                           | 1           | 1                           | 1           | 1                           |

 Not available for the time being



## E-Series winch 46 & 52

| Description                                                  | Art. No.   |                                                                                     | E46/E52    |                             |             |                             |             |                             |             |                             |
|--------------------------------------------------------------|------------|-------------------------------------------------------------------------------------|------------|-----------------------------|-------------|-----------------------------|-------------|-----------------------------|-------------|-----------------------------|
|                                                              |            |                                                                                     | BASIC      |                             | SMF SYNC RB |                             | SMF SYNC RC |                             | SMF SYNC RD |                             |
|                                                              |            |                                                                                     | 532-825-07 | 532-825-08<br>Excl. buttons | 532-825-09  | 532-825-10<br>Excl. buttons | 532-825-11  | 532-825-12<br>Excl. buttons | 532-825-13  | 532-825-14<br>Excl. buttons |
| MCU (Motor Control Unit),<br>BASIC                           | 532-815-47 |    | 1          | 1                           | -           | -                           | -           | -                           | -           | -                           |
| MCU (Motor Control Unit),<br>SMF SYNC RB                     | 532-815-48 |                                                                                     | -          | -                           | 1           | 1                           | -           | -                           | -           | -                           |
| MCU (Motor Control Unit),<br>SMF SYNC RC                     | 532-815-49 |                                                                                     | -          | -                           | -           | -                           | 1           | 1                           | -           | -                           |
| MCU (Motor Control Unit),<br>SMF SYNC RD                     | 532-815-43 |                                                                                     | -          | -                           | -           | -                           | -           | -                           | 1           | 1                           |
| Push button assembly for<br>winch, 1-2                       | 540-457-01 |    | 1          | -                           | 1           | -                           | 1           | -                           | 1           | -                           |
| SEL-Bus Push button<br>converter for Winch<br>(excl buttons) | 532-827-01 |    | 1          | 1                           | 1           | 1                           | 1           | 1                           | 1           | 1                           |
| Button protection panel<br>Excl. buttons                     | 540-482    |  | 1          | -                           | 1           | -                           | 1           | -                           | 1           | -                           |
| SEL-Bus T-connector<br>(Female/Female/Male)                  | 532-839    |  | 2          | 2                           | 2           | 2                           | 2           | 2                           | 2           | 2                           |
| SEL-Bus cable (Female/Male),<br>1 M                          | 531-102    |  | 1          | 1                           | 1           | 1                           | 1           | 1                           | 1           | 1                           |
| SEL-Bus cable (Female/Male),<br>2 M                          | 531-103    |                                                                                     | 1          | 1                           | 1           | 1                           | 1           | 1                           | 1           | 1                           |

 Not available for the time being

## E-Series winch 60 & 66

| Description                                                  | Art. No.   |                                                                                     | E60/E66    |                             |             |                             |             |                             |
|--------------------------------------------------------------|------------|-------------------------------------------------------------------------------------|------------|-----------------------------|-------------|-----------------------------|-------------|-----------------------------|
|                                                              |            |                                                                                     | BASIC      |                             | SMF SYNC RC |                             | SMF SYNC RD |                             |
|                                                              |            |                                                                                     | 532-825-15 | Excl. buttons<br>532-825-16 | 532-825-17  | Excl. buttons<br>532-825-18 | 532-825-19  | Excl. buttons<br>532-825-20 |
| MCU (Motor Control Unit),<br>BASIC                           | 532-815-50 |    | 1          | 1                           | -           | -                           | -           | -                           |
| MCU (Motor Control Unit),<br>SMF SYNC RC                     | 532-815-51 |                                                                                     | -          | -                           | 1           | 1                           | -           | -                           |
| MCU (Motor Control Unit),<br>SMF SYNC RB                     | 532-815-52 |                                                                                     | -          | -                           | -           | -                           | 1           | 1                           |
| Push button assembly for<br>winch, 1-2                       | 540-457-01 |    | 1          | -                           | 1           | -                           | 1           | -                           |
| SEL-Bus Push button<br>converter for Winch<br>(excl buttons) | 532-827-01 |    | 1          | 1                           | 1           | 1                           | 1           | 1                           |
| Button protection panel<br>Excl. buttons                     | 540-482    |   | 1          | -                           | 1           | -                           | 1           | -                           |
| SEL-Bus T-connector<br>(Female/Female/Male)                  | 532-839    |  | 2          | 2                           | 2           | 2                           | 2           | 2                           |
| SEL-Bus cable<br>(Female/Male), 1 M                          | 531-102    |  | 1          | 1                           | 1           | 1                           | 1           | 1                           |
| SEL-Bus cable<br>(Female/Male), 2 M                          | 531-103    |                                                                                     | 1          | 1                           | 1           | 1                           | 1           | 1                           |

 Not available for the time being

### 3. Optional items

|                                                                                     |            |                                                                                      |                                                                                                                                     |
|-------------------------------------------------------------------------------------|------------|--------------------------------------------------------------------------------------|-------------------------------------------------------------------------------------------------------------------------------------|
| Flat button panel, stainless steel for 1 button. 56x56 mm<br>Excl. button           | 540-461-01 |     | <i>Panel to be used if buttons are mounted in a laminate thicker than 5mm</i>                                                       |
| Flat button panel, stainless steel for 2 buttons. 100x56 mm<br>Excl. buttons        | 540-462-01 |    |                                                                                                                                     |
| Button protection panel, black polyamide 96x53 mm, (For 2 buttons)<br>Excl. buttons | 540-482    |    | <i>Buttons are recessed to decrease risk of involuntary activation.<br/>Included by default in control pack for winches</i>         |
| Connection box with cable glands                                                    | 532-487-01 |    | <i>Connector for connection cables (drive unit to MCU). IP66.<br/>Included by default in Furlex Electric above deck Basic Pack.</i> |
| SEL-Bus T-connector<br>F-F-M                                                        | 532-839    |   | <i>T - Connector for SEL-Bus</i>                                                                                                    |
| SEL-Bus T-Conn. Multiport,<br>F-F-F-F-M                                             | 532-841    |  | <i>Multiport connector for SEL-Bus.</i>                                                                                             |

## Optional SEL-Bus & power cables

|                           |                                    |         |                                |
|---------------------------|------------------------------------|---------|--------------------------------|
| <b>SEL-Bus<br/>cables</b> | SEL-Bus cable (Female/Male), 0.3 M | 531-101 | <i>Backbone and drop cable</i> |
|                           | SEL-Bus cable (Female/Male), 1 M   | 531-102 |                                |
|                           | SEL-Bus cable (Female/Male), 2 M   | 531-103 |                                |
|                           | SEL-Bus cable (Female/Male), 5 M   | 531-104 |                                |
|                           | SEL-Bus cable (Female/Male), 10 M  | 531-105 | <i>Backbone only</i>           |

|                         |                                                    |            |                                                                                                                                         |
|-------------------------|----------------------------------------------------|------------|-----------------------------------------------------------------------------------------------------------------------------------------|
| <b>Power<br/>cables</b> | Power cable 6mm <sup>2</sup> , Yellow              | 531-048    | <i>6mm<sup>2</sup>, tinned cable. Sold per meter.<br/>Total max length (sum of plus and minus cables) from PSU to MCU = 18m (2x9m).</i> |
|                         | Power cable 6mm <sup>2</sup> , Blue                | 531-049    |                                                                                                                                         |
|                         | Power cable pack 6mm <sup>2</sup> , Yellow & Blue  | 531-048-10 | <i>Length 2x9m, tinned cable.</i>                                                                                                       |
|                         | Power cable 10mm <sup>2</sup> , Yellow             | 531-050    | <i>10mm<sup>2</sup>, tinned cable.<br/>Total max length (sum of plus and minus cables) from PSU to MCU = 40m (2x20m).</i>               |
|                         | Power cable 10mm <sup>2</sup> , Blue               | 531-051    |                                                                                                                                         |
|                         | Power cable pack 10mm <sup>2</sup> , Yellow & Blue | 531-050-10 | <i>Length 2x15m, tinned cable.</i>                                                                                                      |
|                         | Power cable pack 10mm <sup>2</sup> , Yellow & Blue | 531-050-11 | <i>Length 2x20m, tinned cable.</i>                                                                                                      |

## 4. Examples of installation

Example of installation with **Furlex Electric, E40i** and **Synchronized Main Furling**.

- ① Backbone
- ② Drop cables

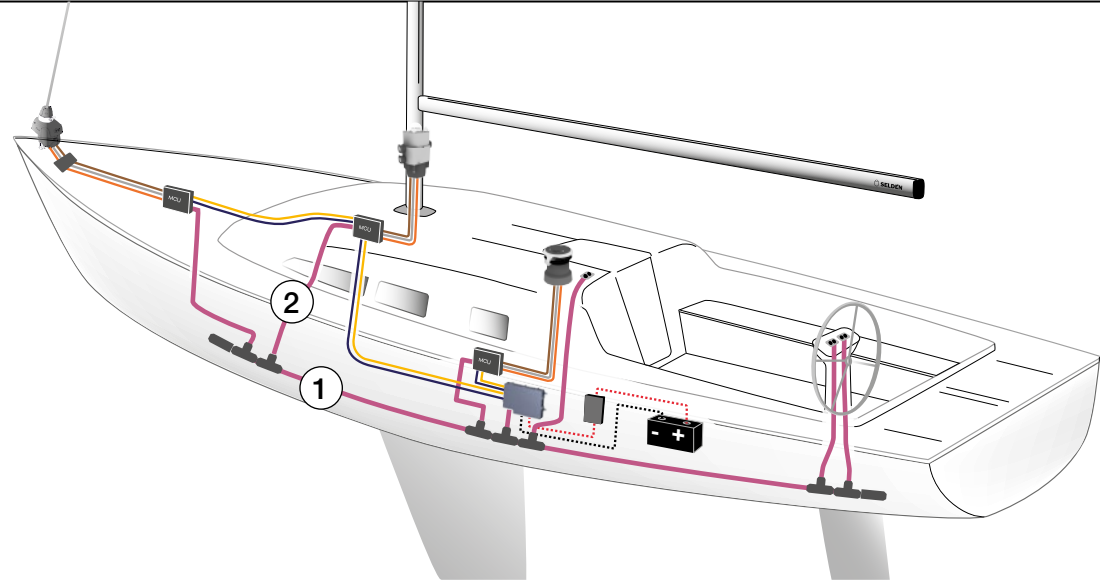

Example of installation with power supply and SEL-Bus system, **CXe25** electric downwind furler, **Furlex Electric 204E**, **Synchronized Main Furling** (Electric furling mast RB and **E40i** Winch) and **E52** E-Series winches in boat with 12V power system.

QTY    Package Description

|   |            |                              |
|---|------------|------------------------------|
| 1 | 532-800-20 | PSU Start pack 12V           |
| 1 | 532-815-70 | Control Pack CXe25           |
| 1 | 532-815-60 | Control Pack Furlex 200/204E |
| 1 | 532-815-72 | Control Pack Main RB SYNC    |
| 1 | 532-815-82 | Control Pack E40i RB SYNC    |
| 2 | 475-752-10 | Control Pack E52             |

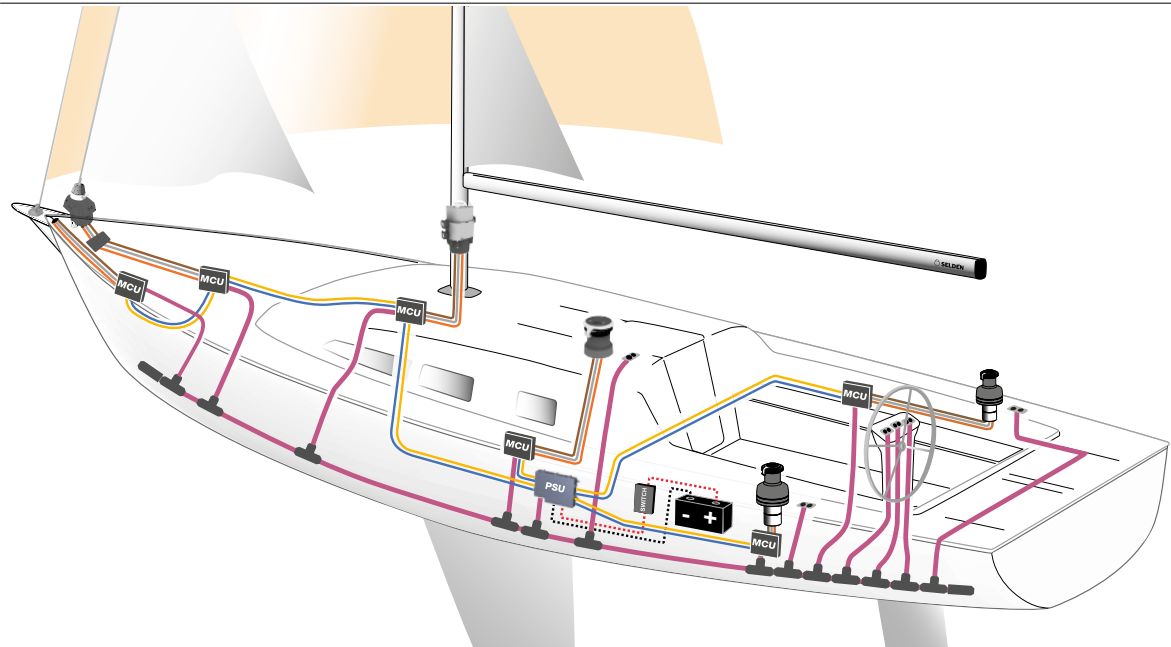

# DINGHIESKEELBOATSYACHTS

**Seldén Mast AB, Sweden**  
Tel +46 (0)31 69 69 00  
e-mail [info@seldenmast.com](mailto:info@seldenmast.com)

**Seldén Mast Limited, UK**  
Tel +44 (0)1329 50 40 00  
e-mail [info@seldenmast.co.uk](mailto:info@seldenmast.co.uk)

**Seldén Mast Inc., USA**  
Tel +1 843-760-6278  
e-mail [info@seldenus.com](mailto:info@seldenus.com)

**Seldén Mast A/S, Denmark**  
Tel +45 39 18 44 00  
e-mail [info@seldenmast.dk](mailto:info@seldenmast.dk)

**Seldén Mid Europe B.V.,  
Netherlands**  
Tel +31 (0)111-698 120  
e-mail [info@seldenmast.nl](mailto:info@seldenmast.nl)

**Seldén Mast SAS, France**  
Tel +33 (0)251 362 110  
e-mail [info@seldenmast.fr](mailto:info@seldenmast.fr)

[www.seldenmast.com](http://www.seldenmast.com)

The Seldén Group is the world's leading manufacturer of mast and rigging systems in carbon and aluminium for dinghies, keelboats and yachts.

Our well known brands are Seldén and Furlex. The worldwide success of Furlex has enabled us to build a network of over 750 authorised dealers covering the world's marine markets. So wherever you sail, you can be sure of fast access to our service, spare parts and know-how.

Seldén, Furlex and SEL-Bus are registered trademarks of Seldén Mast AB.

