

# Seldén Sail hardware

## OWS sliders and Batten receptacles



### 3.5 OWS (Outer Wheel Support) slider

Seldén OWS sliders are designed both as batten sliders and webbing sliders. Each model is available in 5 different versions. One version fits Seldén E-sections (1977-2002) and older Seldén/Kemp oval sections. Any of the other 4 versions fits most of all other mast brands on the market.

OWS sliders do not fit Seldén C-section for which MDS-sliders should be used.

#### OWS slider for webbing

To achieve maximum strength, the OWS slider should be attached to the main sail using a webbing strap.

All sliders for webbing can be used for headboard attachments and as intermediate sliders.

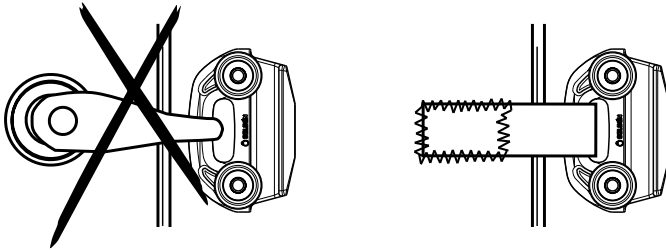

#### OWS slider for batten

The OWS batten slider is designed to take compression load from the batten in a full batten main sail. To achieve optimal function and strength, use Seldén toggle M10 stud 511-739-01.

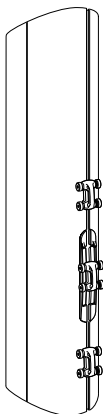
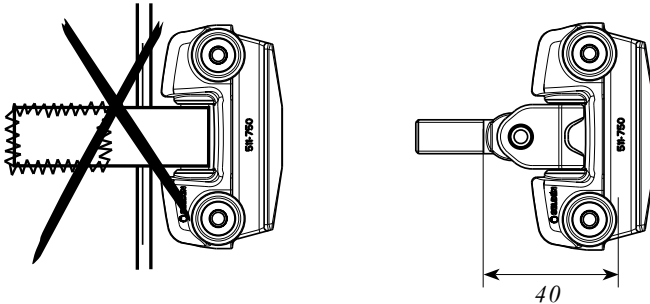

#### OWS compatible sail feeder gates

The OWS E-section slider (511-740 and 511-750) can be used with, and **passes through** Seldén sail feeder gate 505-501-01.

The OWS sliders 511-744 and 511-754 for keelboat sections (C106-C139) can be used with and passes through Seldén sail feeder gate 505-533-02.

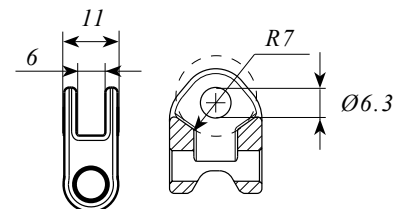
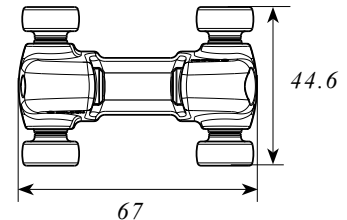
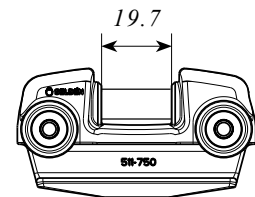
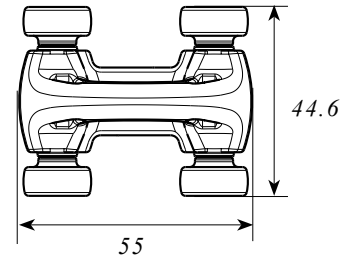
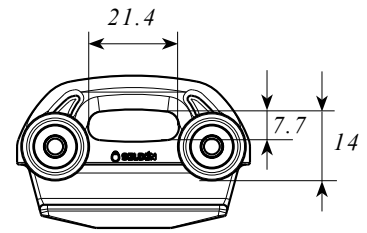



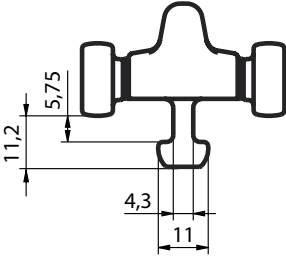
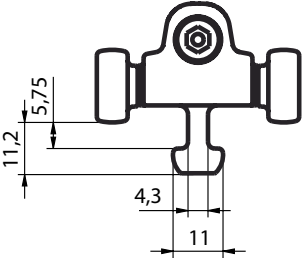
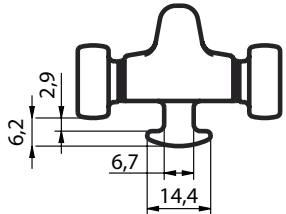
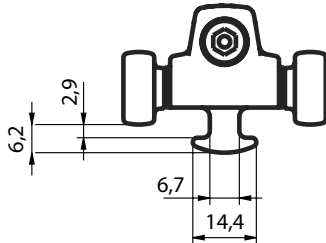
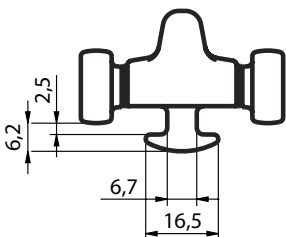
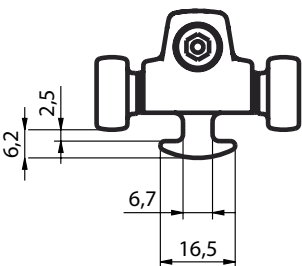
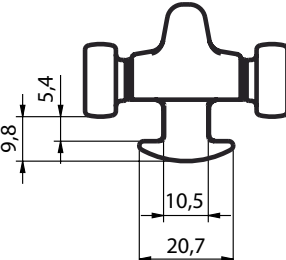
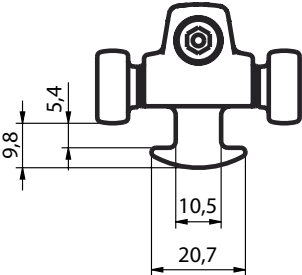
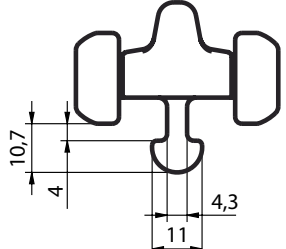
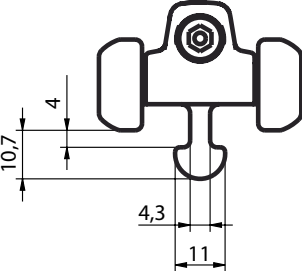











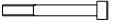











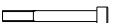































### 3.5.1 OWS slider dimensions

Type	Measurements (mm)	Type	Measurements (mm)
OWS slider webbing 511-740		OWS slider batten 511-750	
OWS slider webbing 511-741		OWS slider batten 511-751	
OWS slider webbing 511-742		OWS slider batten 511-752	
OWS slider webbing 511-743 1)		OWS slider batten 511-753 1)	
OWS slider webbing 511-744		OWS slider batten 511-754	

All sliders for webbing can be used for headboard attachments and as intermediate sliders.

1) OWS sliders do not fit Seldén C-section for which MDS-sliders should be used.

Type	Art. No.	Fits luff groove (mm)	Breaking load (N)	Assembly Art. No.	Parts Art. No.		
OWS slider webbing	 511-740	5.5	5000	 511-740-01			
OWS slider batten	 511-750	5.5	7000	 511-750-03	 511-750-01	 511-739-01 M10 screw	 153-117
				 511-750-02	 511-750-01		 153-117
OWS slider webbing	 511-741	10	5000	 511-741-01			
OWS slider batten	 511-751	10	7000	 511-751-03	 511-751-01	 511-739-01 M10 screw	 153-117
				 511-751-02	 511-751-01		 153-117
OWS slider webbing	 511-742	10	5000	 511-742-01			
OWS slider batten	 511-752	10	7000	 511-752-03	 511-752-01	 511-739-01 M10 screw	 153-117
				 511-752-02	 511-752-01		 153-117
OWS slider webbing	 511-743	12	5000	 511-743-01			
OWS slider batten	 511-753	12	7000	 511-753-03	 511-753-01	 511-739-01 M10 screw	 153-117
				 511-753-02	 511-753-01		 153-117
OWS slider webbing Big wheel	 511-744	5.5	5000	 511-744-01			
OWS slider batten Big wheel	 511-754	5.5	7000	 511-754-03	 511-754-01	 511-739-01 M10 screw	 153-117
				 511-754-02	 511-754-01		 153-117

Type	Corresponding slider Holt Allen Bainbridge	Fits mast section (only geometric fit)
<p>OWS slider webbing 511-740</p>  <p>OWS slider batten 511-750</p> 		<p><b>All Seldén E sections and D section (1971-2002)</b>  <b>Sparcraft:</b> F135; F195; F305; F385; F460; I620; S622; I830; S830  <b>Z-Spars:</b> Z301; Z351; Z380; Z401; Z531; Z601; Z602; Z701; Z702  <b>Soromap:</b> NF200; NF270; NF350; NF430; NF540; NF710; NF1410</p>
<p>OWS slider webbing 511-741</p>  <p>OWS slider batten 511-751</p> 	<p>HA 89 A 007</p>	
<p>OWS slider webbing 511-742</p>  <p>OWS slider batten 511-752</p> 	<p>HA 90 A 008</p>	<p><b>Briand/Pettersson</b> 180x130 mm MkII (Maxi 95 from hull #250)  <b>Briand/Pettersson</b> 125x100 mm (Maxi 77)</p>
<p>OWS slider webbing 511-743</p>  <p>OWS slider batten 511-753</p> 	<p>HA 91 A 009</p>	<p><b>Isomat</b> NG70  <b>Briand/Pettersson</b> 160x120 mm (Maxi 87)  <b>Sparcraft:</b> NG60; NG70; NG80; NG86; F580; F740; F1060; F1395; S1630;  S2100; F2390; F3360; F4600  <b>Z-Spars:</b> Z902; Z1001; Z1250; Z1400</p>
<p>OWS slider webbing 511-744</p>  <p>OWS slider batten 511-754</p> 		<p><b>Seldén:</b> C106; C116; C126; C139  <b>Sparcraft:</b> F35; F50; F67; F78; F101; S137; S180; S260; IMS80; IMS256  <b>Z-Spars:</b> Z170; Z190; Z230; Z265; Z501</p>

## Batten receptacles

*Each size of the adjustable batten receptacles is available in two models to ensure correct fit on round, flat and rectangular battens.*

*Safety cord secures the cover to the body.*

*The FA-models have access to the adjustment screw both front and rear which enables adjustment of the batten even when the sail is flaked on the boom. The adjustment screw is compatible with multiple screw heads.*

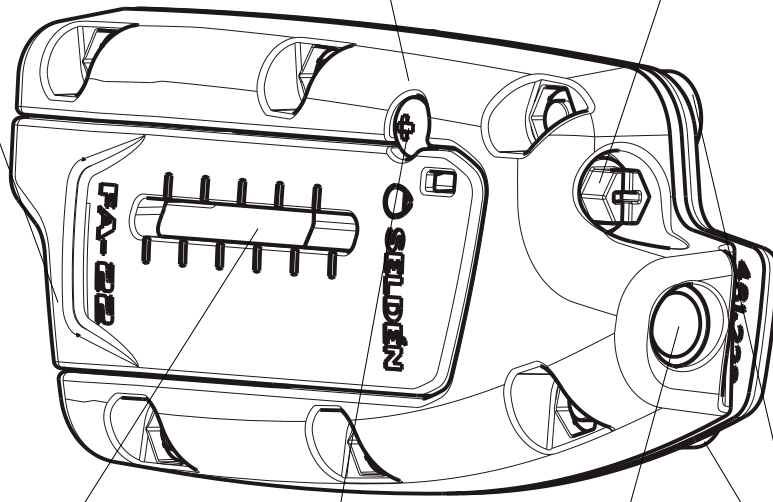

*M10 thread.*

*Indicators to record batten tension for the ultimate trim.*

*Easy set up and removal of batten with sliding cover and a locking screw. No need to fully release the screw to remove the cover.*

*Protecting collar at the backing plate prevents the forward screw heads to chafe on the mast surface.*

## Batten receptacle fitting

The fittings are designed to be used with toggle M10 stud (511-712-01, 511-727-02 or 511-739-01).

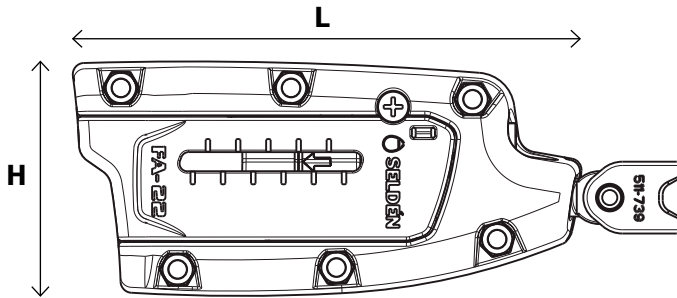

The adjustable batten receptacles are available for either round or rectangular battens.

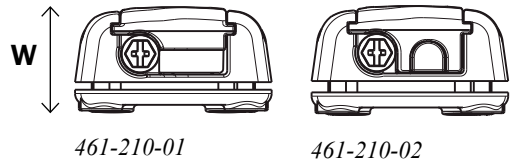

## Batten receptacle range

Type Dimensions L x H x W (mm)	Art. No.	Batten sizes (mm)		Batten receptacle		Adj. length (mm)	Stud dim.
		Round	Flat				
P-30 85x56x18	461-237-01	Ø10	5.5x31			-	M10
P-40	461-235-01	Ø10	5.5x41			-	M10
A-17 125x52x28	461-210-01	-	6.5x18			38	M10
	461-210-02	Ø8	-				
FA-22 134x62x20	461-220-01	-	9.5x23			33	M10
	461-220-02	Ø10	-				
FA-30 134x72x20	461-230-01	-	6.5x31			36	M10
	461-230-02	Ø12	-				

# DINGHIESKEELBOATSYACHTS

**Seldén Mast AB, Sweden**  
Tel +46 (0)31 69 69 00  
Fax +46 (0)31 29 71 37  
e-mail [info@seldenmast.com](mailto:info@seldenmast.com)

**Seldén Mast Limited, UK**  
Tel +44 (0) 1329 504000  
Fax +44 (0) 1329 504049  
e-mail [info@seldenmast.co.uk](mailto:info@seldenmast.co.uk)

**Seldén Mast Inc., USA**  
Tel +1 843-760-6278  
Fax +1 843-760-1220  
e-mail [info@seldenus.com](mailto:info@seldenus.com)

**Seldén Mast A/S, DK**  
Tel +45 39 18 44 00  
Fax +45 39 27 17 00  
e-mail [info@seldenmast.dk](mailto:info@seldenmast.dk)

**Seldén Mid Europe B.V., NL**  
Tel +31 (0) 111-698 120  
Fax +31 (0) 111-698 130  
e-mail [info@seldenmast.nl](mailto:info@seldenmast.nl)

**Seldén Mast SAS, FR**  
Tel +33 (0) 251 362 110  
Fax +33 (0) 251 362 185  
e-mail [info@seldenmast.fr](mailto:info@seldenmast.fr)

**Seldén Mast Asia Ltd,  
Hong Kong**  
Tel +852 3572 0613  
Fax +852 3572 0623  
e-mail [info@seldenmast.com.hk](mailto:info@seldenmast.com.hk)

[www.seldenmast.com](http://www.seldenmast.com)

Dealer:

The Seldén Group is the world's leading manufacturer of masts and rigging systems in carbon and aluminium for dinghies, keelboats and yachts.

Our well known brands are Seldén and Furlex.

The worldwide success of Furlex has enabled us to build a network of over 750 authorised dealers covering the world's marine markets. So wherever you sail, you can be sure of fast access to our service, spare parts and know-how.

SELDÉN and FURLEX are registered trademarks of Seldén Mast AB

